



WACKER NEUSON

Operator's Manual

Portable Generator

GP 5600A GPS 5600A

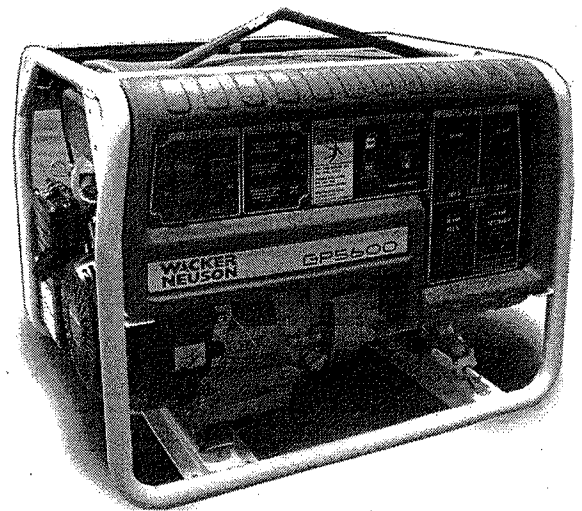

EN

5000192945	01	0511
------------	----	------



5 0 0 0 1 9 2 9 4 5

Copyright notice

© Copyright 2011 by Wacker Neuson Production Americas LLC
All rights, including copying and distribution rights, are reserved.
This publication may be photocopied by the original purchaser of the machine. Any other type of reproduction is prohibited without express written permission from Wacker Neuson Production Americas LLC.
Any type of reproduction or distribution not authorized by Wacker Neuson Production Americas LLC represents an infringement of valid copyrights. Violators will be prosecuted.

Trademarks

All trademarks referenced in this manual are the property of their respective owners.

Manufacturer

Wacker Neuson Production Americas LLC
N92W15000 Anthony Avenue
Menomonee Falls, WI 53051 U.S.A.
Tel: (262) 255-0500 · Fax: (262) 255-0550 · Tel: (800) 770-0957
www.wackerneuson.com

Original instructions

This Operator's Manual presents the original instructions. The original language of this Operator's Manual is American English.

Foreword

SAVE THESE INSTRUCTIONS—This manual contains important instructions for the machine models listed below. These instructions must be followed during installation and maintenance of the generator (and battery, if equipped).

Machines covered in this manual

Machine	Item Number
GP 5600A	0620979, 0620980, 0620983, 0620984
GPS 5600A	0620981, 0620982

Machine documentation

- From this point forward in this documentation, Wacker Neuson Production Americas LLC will be referred to as Wacker Neuson.
- Keep a copy of the Operator's Manual with the machine at all times.
- Use the separate Parts Book supplied with the machine to order replacement parts.
- Refer to the separate Repair Manual for detailed instructions on servicing and repairing the machine.
- If you are missing any of these documents, please contact Wacker Neuson to order a replacement or visit www.wackerneuson.com.
- When ordering parts or requesting service information, be prepared to provide the machine model number, item number, revision number, and serial number.

Expectations for information in this manual

- This manual provides information and procedures to safely operate and maintain the above Wacker Neuson model(s). For your own safety and to reduce the risk of injury, carefully read, understand, and observe all instructions described in this manual.
- Wacker Neuson expressly reserves the right to make technical modifications, even without notice, which improve the performance or safety standards of its machines.
- The information contained in this manual is based on machines manufactured up until the time of publication. Wacker Neuson reserves the right to change any portion of this information without notice.

CALIFORNIA Proposition 65 Warning

Engine exhaust, some of its constituents, and certain vehicle components, contain or emit chemicals known to the State of California to cause cancer and birth defects or other reproductive harm.

Laws pertaining to spark arresters

NOTICE: State Health Safety Codes and Public Resources Codes specify that in certain locations spark arresters be used on internal combustion engines that use hydrocarbon fuels. A spark arrester is a device designed to prevent accidental discharge of sparks or flames from the engine exhaust. Spark arresters are qualified and rated by the United States Forest Service for this purpose. In order to comply with local laws regarding spark arresters, consult the engine distributor or the local Health and Safety Administrator.

Manufacturer's approval

This manual contains references to *approved* parts, attachments, and modifications. The following definitions apply:

Foreword

- **Approved parts or attachments** are those either manufactured or provided by Wacker Neuson.
- **Approved modifications** are those performed by an authorized Wacker Neuson service center according to written instructions published by Wacker Neuson.
- **Unapproved parts, attachments, and modifications** are those that do not meet the approved criteria.

Unapproved parts, attachments, or modifications may have the following consequences:

- Serious injury hazards to the operator and persons in the work area
- Permanent damage to the machine which will not be covered under warranty

Contact your Wacker Neuson dealer immediately if you have questions about approved or unapproved parts, attachments, or modifications.



Foreword	3
1 Safety Information	7
1.1 Signal Words Used in this Manual	7
1.2 Machine Description and Intended Use	8
1.3 Operating Safety	9
1.4 Operator Safety while Using Internal Combustion Engines	12
1.5 Service Safety	13
2 Labels	15
2.1 Label Locations	15
2.2 Label Meanings	16
3 Operation	21
3.1 Preparing for first use	21
3.2 Recommended Fuel	22
3.3 Determining Power Requirements	23
3.4 Installation	24
3.5 Recommended Battery (GPS only)	24
3.6 Battery Tray Installation (GPS only)	25
3.7 Wheel Kit	26
3.8 Generator Derating	28
3.9 Grounding the Generator	29
3.10 Operating Heavy Loads	29
3.11 Use of Extension Cords	30
3.12 Control Panel	31
3.13 Ground Fault Interrupt (GFI / GFCI)	32
3.14 Twist-Lock Receptacles	33
3.15 Engine Auto Idle	33
3.16 Engine Speed	33
3.17 Voltage Selector Switch	34
3.18 Before Starting	35
3.19 Starting	36
3.20 Stopping	37
3.21 Emergency Shutdown Procedure	37

4	Maintenance	38
4.1	Maintaining the Emission Control System	38
4.2	Periodic Maintenance Schedule	38
4.3	Engine Oil	39
4.4	Servicing the Air Cleaner	40
4.5	Spark Plug	41
4.6	Cleaning the Sediment Cup	42
4.7	Engine Speed	42
4.8	Long-Term Storage	43
4.9	Transporting the Machine	43
4.10	Troubleshooting	44
5	Technical Data	45
5.1	Generator	45
5.2	Engine	46
6	Emission Control Systems Information and Warranty	49
6.1	Emission Control System Background Information	49
6.2	Limited Defect Warranty for Exhaust Emission Control System	50
6.3	Limited Defect Warranty for Wacker Neuson Evaporative Emission Control Systems	51
6.4	California Evaporative Emission Control Warranty Statement	54
6.5	Limited Defect Warranty for Exhaust Emission Control System	55
7	Schematics	56
7.1	Wire Colors	56
7.2	US Machines—Electrical Schematic	56
7.3	CSA Machines—Electrical Schematic	58
7.4	Engine Wiring	60

1 Safety Information

1.1 Signal Words Used in this Manual

This manual contains DANGER, WARNING, CAUTION, *NOTICE*, and NOTE signal words which must be followed to reduce the possibility of personal injury, damage to the equipment, or improper service.



This is the safety alert symbol. It is used to alert you to potential personal hazards.
▶ Obey all safety messages that follow this symbol.



DANGER

DANGER indicates a hazardous situation which, if not avoided, will result in death or serious injury.

- ▶ To avoid death or serious injury from this type of hazard, obey all safety messages that follow this signal word.



WARNING

WARNING indicates a hazardous situation which, if not avoided, could result in death or serious injury.

- ▶ To avoid possible death or serious injury from this type of hazard, obey all safety messages that follow this signal word.



CAUTION

CAUTION indicates a hazardous situation which, if not avoided, could result in minor or moderate injury.

- ▶ To avoid possible minor or moderate injury from this type of hazard, obey all safety messages that follow this signal word.

NOTICE: Used without the safety alert symbol, NOTICE indicates a situation which, if not avoided, could result in property damage.

Note: A Note contains additional information important to a procedure.

1.2 Machine Description and Intended Use

This machine is a portable electric power source. The Wacker Neuson Portable Generator consists of a tubular steel frame surrounding a fuel tank, a gasoline engine, a control panel, and an electric alternator. The control panel includes controls and receptacles. As the engine runs, the generator converts mechanical energy into electric power. The operator connects loads to the electric power receptacles.

This machine is intended for the purpose of supplying electrical power to connected loads. Refer to the product specifications for the output voltage and frequency of this generator, and the maximum output power limit of this generator.

This machine has been designed and built strictly for the intended use described above. Using the machine for any other purpose could permanently damage the machine or seriously injure the operator or other persons in the area. Machine damage caused by misuse is not covered under warranty.

The following are some examples of misuse:

Connecting a load that has voltage and frequency requirements that are incompatible with the generator output

Overloading the generator with a load that draws excessive power during either continuous running or start-up

Operating the generator in a manner that is inconsistent with all federal, state and local codes and regulations

Using the machine as a ladder, support, or work surface

Using the machine to carry or transport passengers or equipment

Operating the machine outside of factory specifications

Operating the machine in a manner inconsistent with all warnings found on the machine and in the Operator's Manual

This machine has been designed and built in accordance with the latest global safety standards. It has been carefully engineered to eliminate hazards as far as practicable and to increase operator safety through protective guards and labeling. However, some risks may remain even after protective measures have been taken. They are called residual risks. On this machine, they may include exposure to:

Heat, noise, exhaust, and carbon monoxide from the engine

Fire hazards from improper refueling techniques

Fuel and its fumes

Electric shock and arc flash

Personal injury from improper lifting techniques

To protect yourself and others, make sure you thoroughly read and understand the safety information presented in this manual before operating the machine.

1.3 Operating Safety



DANGER

Carbon monoxide. Using a generator indoors CAN KILL YOU IN MINUTES. Generator exhaust contains carbon monoxide (CO). This is a poison you cannot see or smell. If you can smell the generator exhaust, you are breathing CO. But even if you cannot smell the exhaust, you could be breathing CO.

- ▶ NEVER use a generator inside homes, garages, crawlspaces, or other partly enclosed areas. Deadly levels of carbon monoxide can build up in these areas. Using a fan or opening windows and doors does NOT supply enough fresh air.
- ▶ ONLY use a generator outside and far away from windows, doors, and vents. These openings can pull in generator exhaust.
- ▶ Even when you use a generator correctly, CO may leak into the home. ALWAYS use a battery-powered or battery-backup CO alarm in the home.
- ▶ If you start to feel sick, dizzy, or weak after the generator has been running, move to fresh air RIGHT AWAY. See a doctor. You could have carbon monoxide poison.

Operator qualifications

Only trained personnel are permitted to start, operate, and shut down the machine. They also must meet the following qualifications:

- have received instruction on how to properly use the machine
- are familiar with required safety devices

The machine must not be accessed or operated by:

- children
- people impaired by alcohol or drugs

Personal Protective Equipment (PPE)

Wear the following Personal Protective Equipment (PPE) while operating this machine:

- Close-fitting work clothes that do not hinder movement
- Safety glasses with side shields
- Hearing protection
- Safety-toed footwear



DANGER

BACKFEED FROM THE GENERATOR INTO THE PUBLIC POWER DISTRIBUTION SYSTEM CAN CAUSE SERIOUS INJURY OR DEATH TO UTILITY WORKERS!

Improper connection of generator to a building's electrical system can allow electrical current from the generator to backfeed into utility lines. This may result in electrocution of utility workers, fire, or explosion. Connections to a building's electrical system must be made by a qualified electrician and comply with all applicable laws and electrical codes.

If connected to a building's electrical system the generator must meet the power, voltage, and frequency requirements of the equipment in the building. Differences in power, voltage, and frequency requirements may exist and improper connection may lead to equipment damage, fire, and personal injury or death.



Familiarity and proper training are required for the safe operation of the machine. Machines operated improperly or by untrained personnel can be hazardous. Read the operating instructions contained in this manual and the engine manual, and familiarize yourself with the location and proper use of all controls. Inexperienced operators should receive instruction from someone familiar with the machine before being allowed to operate it.

- 1.3.1 NEVER operate the generator when open containers of fuel, paint, or other flammable liquids are near.
- 1.3.2 NEVER operate the generator, or tools attached to the generator, with wet hands.
- 1.3.3 NEVER use worn electrical cords. Severe electrical shock and equipment damage may result.
- 1.3.4 NEVER run the electrical cords under the generator, or over vibrating or hot parts.
- 1.3.5 NEVER enclose or cover the generator when it is in use or when it is hot.
- 1.3.6 NEVER overload the generator. The total amperage of the tools and equipment attached to the generator must not exceed the load rating of the generator.
- 1.3.7 NEVER operate the machine in snow, rain, or standing water.
- 1.3.8 NEVER allow untrained personnel to operate or service the generator. The generator set should be set up by a certified electrician.
- 1.3.9 NEVER stand on the machine.
- 1.3.10 DO NOT stand under the machine while it is being hoisted or moved.
- 1.3.11 DO NOT attach equipment to the machine when it is suspended.
- 1.3.12 Store the machine properly when it is not being used. The machine should be stored in a clean, dry location out of the reach of children.
- 1.3.13 ALWAYS position and operate the generator on a firm, noncombustible, level surface.
- 1.3.14 ALWAYS transport the generator in an upright position.

- 1.3.15 ALWAYS keep the machine at least one meter (three feet) away from structures, buildings, and other equipment during use.
- 1.3.16 ALWAYS keep the area immediately surrounding and underneath the machine clean, neat, and free of debris and combustible materials. Make sure that the area overhead is clear of debris that could fall onto or into the machine or exhaust compartment.
- 1.3.17 ALWAYS remove all tools, cords, and other loose items from the generator before starting it.
- 1.3.18 ALWAYS make certain the machine is well-grounded and securely fastened to a good earthen ground per national and local regulations.

1.4 Operator Safety while Using Internal Combustion Engines

**WARNING**

Internal combustion engines present special hazards during operation and fueling. Failure to follow the warnings and safety standards could result in severe injury or death.

- ▶ Read and follow the warning instructions in the engine owner's manual and the safety guidelines below.

**DANGER**

- ▶ **Carbon monoxide.** Using a generator indoors CAN KILL YOU IN MINUTES. Generator exhaust contains carbon monoxide (CO). This is a poison you cannot see or smell. If you can smell the generator exhaust, you are breathing CO. But even if you cannot smell the exhaust, you could be breathing CO.

Refueling safety

When refueling the engine:

- Do not smoke.
- Do not refuel if the generator is sitting in a truck fitted with a plastic bed liner. Static electricity can ignite the fuel or fuel vapors.
- Do not refuel a hot or running engine.
- Do not refuel the engine near an open flame.

When refueling the engine, always:

- Refill the fuel tank in a well-ventilated area.
- Replace the fuel tank cap after refueling.

Operating safety

When operating the generator:

- Check the fuel lines and the fuel tank for leaks and cracks before starting the engine.
- Do not run the machine if fuel leaks are present or the fuel lines are loose.
- Do not run the engine near open flames.
- Do not start the engine if fuel has spilled or a fuel odor is present. Move the generator away from the spill and wipe the generator dry before starting.
- Do not smoke while operating the machine.

Generator vibration

Generators vibrate in normal use. During and after the use of the generator, inspect the generator as well as extension cords and power supply cords connected to it for damage from vibration.

- Have damaged items repaired or replaced as necessary.
- Do not use plugs or or cords that show signs of damage such as broken or cracked insulation or damaged blades.

1.5 Service Safety



Poorly maintained equipment can become a safety hazard! In order for the equipment to operate safely and properly over a long period of time, periodic maintenance and occasional repairs are necessary. If the generator is experiencing problems or is being serviced, attach a “DO NOT START” sign to the control panel to notify other people of its condition.

Personal Protective Equipment (PPE)

Wear the following Personal Protective Equipment (PPE) while servicing or maintaining this machine:

- Close-fitting work clothes that do not hinder movement
- Safety glasses with side shields
- Hearing protection
- Safety-toed footwear

In addition, before servicing or maintaining the machine:

- Tie back long hair.
- Remove all jewelry (including rings).

- 1.5.1 Do not use gasoline or other types of fuels or flammable solvents to clean parts, especially in enclosed areas. Fumes from fuels and solvents can become explosive.
- 1.5.2 DO NOT attempt to clean or service the machine while it is running.
- 1.5.3 Do not modify the machine without the express written approval of the manufacturer.
- 1.5.4 DO NOT allow water to accumulate around the base of the machine. If water is present, move the machine and allow the machine to dry before servicing.
- 1.5.5 DO NOT service the machine if your clothing or skin is wet.
- 1.5.6 DO NOT allow untrained personnel to service this equipment. Only trained electrical technicians should be allowed to service the electrical components of this equipment.

- 1.5.7 Keep the machine clean and labels legible. Replace all missing and hard-to-read labels. Labels provide important operating instructions and warn of dangers and hazards.
- 1.5.8 ALWAYS replace the safety devices and guards after repairs and maintenance.
- 1.5.9 ALWAYS let the engine cool before transporting or servicing the machine.
- 1.5.10 ALWAYS keep hands, feet, and loose clothing away from the moving parts on the generator and engine.
- 1.5.11 ALWAYS turn the engine off before servicing the machine. If the engine has electric start, disconnect the negative terminal on the battery before servicing the machine.
- 1.5.12 ALWAYS keep the fuel lines in good condition and properly connected. Leaking fuel and fumes are extremely explosive.
- 1.5.13 When replacement parts are required for this machine, use only Wacker Neuson replacement parts or those parts equivalent to the original in all types of specifications, such as physical dimensions, type, strength, and material.

2 Labels



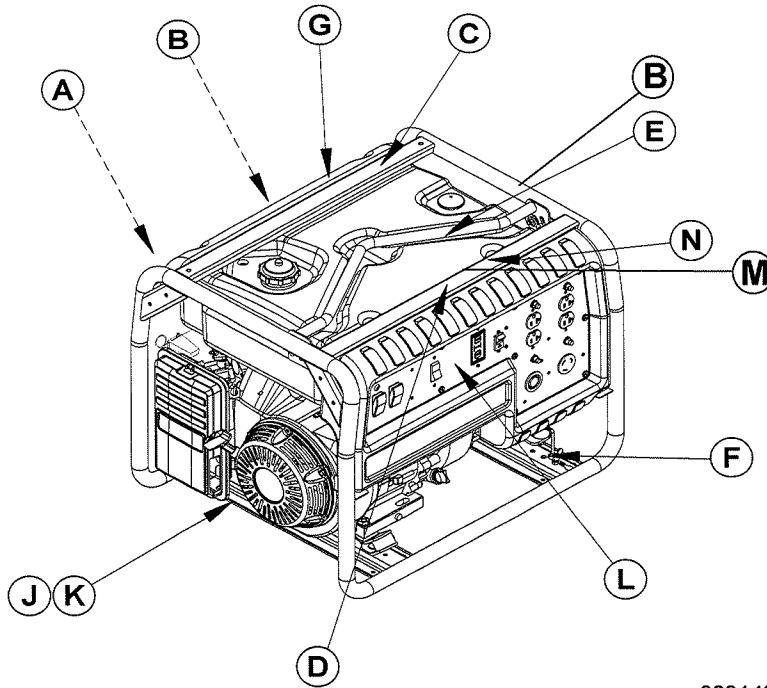

2.1 Label Locations





wc_gr003142

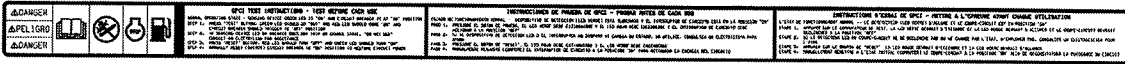

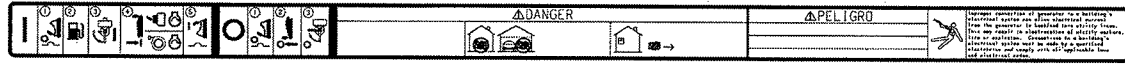
2.2 Label Meanings

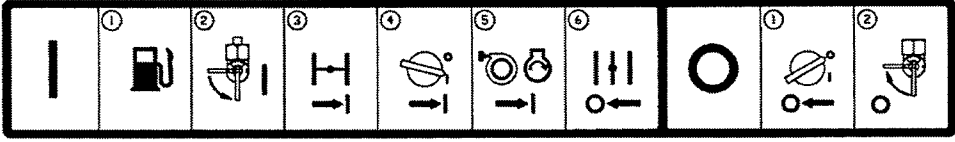
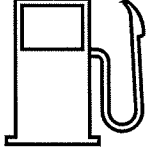
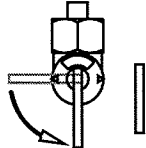
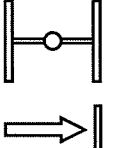
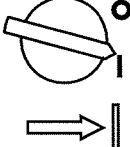
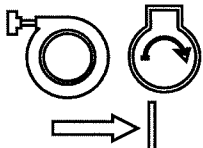
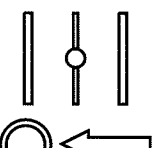
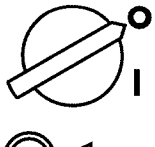
Wacker Neuson machines use international pictorial labels where needed. These labels are described below.

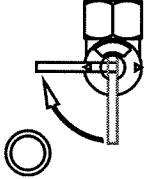
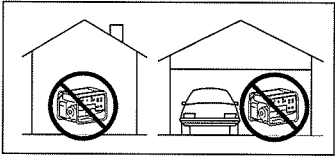
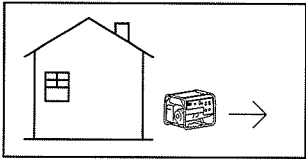
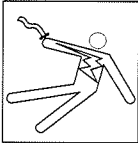
<p>A</p>		<p>Engine Choke Control</p>
<p>B</p>		<p>WARNING! Hot surface!</p>
<p>C</p>		
<p>—</p>		<p>DANGER!</p> <ul style="list-style-type: none"> Read the Operator's Manual. No sparks, flames, or burning objects near the machine. Stop the engine before refueling.
<p>—</p>	<p>GFCI TEST INSTRUCTIONS - TEST BEFORE EACH USE Normal operating state - sensing device green LED is "ON" and circuit breaker is at "ON" position. Step 1: Press "TEST" button. Green LED should go "OUT" and red LED should come "ON" and circuit breaker should trigger to "OFF" position. Step 2: If sensing device LED or breaker does not trip or change state, "DO NOT USE". Consult an electrician for assistance. Step 3: Press "RESET" button. Red LED should turn "OFF" and green LED should turn "ON". Step 4: Manually reset (switch) circuit breaker to "ON" position to restore circuit power.</p>	
<p>D</p>		

<p>—</p>	 <p>172920</p>
<p>—</p>	 <p>CAUTION! Use only clean, filtered gasoline fuel. Check the fuel level.</p>
<p>—</p>	 <p>Open the fuel flow valve.</p>
<p>—</p>	 <p>Close the choke.</p>
<p>—</p>	 <p>Turn the engine switch to the ON position.</p>
<p>—</p>	 <p>Pull the rewind starter.</p>
<p>—</p>	 <p>Open the choke.</p>
<p>—</p>	 <p>Turn the engine switch to "OFF".</p>

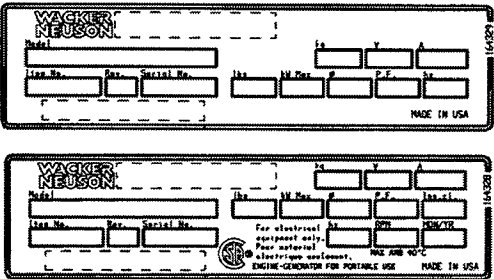
—		Close the fuel flow valve.
—	<p>DANGER Using a generator indoors CAN KILL YOU IN MINUTES. Generator exhaust contains carbon monoxide. This is a poison you cannot see or smell.</p>	
—		NEVER use inside a home or garage, EVEN IF doors and windows are open.
—		Only use OUTSIDE and far away from windows, doors, and vents.
—		<p>WARNING! To reduce the risk of electrical shock and arc flash, read the Operator's Manual. Improper connection of the generator to a building's electrical system can allow electrical current from the generator to backfeed into utility lines. This may result in electrocution of utility workers, fire, or explosion. Connections to a building's electrical system must be made by a qualified electrician and comply with all applicable laws and electrical codes.</p>
E		NOTICE Lifting point.
F		Electrical ground

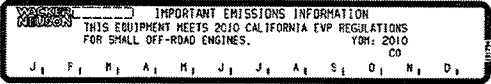
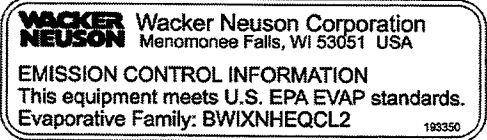
<p>G</p>		<p>WARNING Operation of this equipment may create sparks that can start fires around dry vegetation. A spark arrester may be required. The operator should contact local fire agencies for laws or regulations relating to fire prevention requirements.</p>
<p>J</p>		<p>A nameplate listing the model number, item number, revision number, and serial number is attached to each unit. Please record the information found on this nameplate so it will be available should the nameplate become lost or damaged. When ordering parts or requesting service information, you will always be asked to specify the model number, item number, revision number, and serial number of the unit.</p>
<p>K</p>		<p>This machine may be covered by one or more patents.</p>
<p>L</p>		<p>WARNING! Test GFCI before each use. See label above.</p>
<p>M</p>		<p>Important Emissions Information This equipment meets California EVP emission regulations for small off-road engines.</p>
<p>N</p>		<p>Emission Control Information This equipment meets U.S. EPA EVAP standards. Evaporative Family: BWIXNHEQCL2</p>

Notes:



3 Operation

**DANGER**

Carbon monoxide. Using a generator indoors CAN KILL YOU IN MINUTES. Generator exhaust contains carbon monoxide (CO). This is a poison you cannot see or smell. If you can smell the generator exhaust, you are breathing CO. But even if you cannot smell the exhaust, you could be breathing CO.

- ▶ NEVER use a generator inside homes, garages, crawlspaces, or other partly enclosed areas. Deadly levels of carbon monoxide can build up in these areas. Using a fan or opening windows and doors does NOT supply enough fresh air.
- ▶ ONLY use a generator outside and far away from windows, doors, and vents. These openings can pull in generator exhaust.
- ▶ Even when you use a generator correctly, CO may leak into the home. ALWAYS use a battery-powered or battery-backup CO alarm in the home.
- ▶ If you start to feel sick, dizzy, or weak after the generator has been running, move to fresh air RIGHT AWAY. See a doctor. You could have carbon monoxide poison.

3.1 Preparing for first use

To prepare your machine for first use:

- 3.1.1 Make sure all loose packaging materials have been removed from the machine.
- 3.1.2 Check the machine and its components for damage. If there is visible damage, do not operate the machine! Contact your Wacker Neuson dealer immediately for assistance.
- 3.1.3 Take inventory of all items included with the machine and verify that all loose components and fasteners are accounted for.
- 3.1.4 Attach component parts not already attached.
- 3.1.5 Add fluids as needed and applicable, including fuel, engine oil, and battery acid.
- 3.1.6 Move the machine to its operating location.

3.2 Recommended Fuel

Type

This engine/equipment requires regular unleaded gasoline.

- Use only fresh (no older than three months old), clean gasoline.
- Use a fuel stabilizer per the fuel stabilizer manufacturer's instructions.

Use of oxygenated fuels

Some conventional gasolines are blended with alcohol. These gasolines are collectively referred to as oxygenated fuels. If you use an oxygenated fuel, be sure it is unleaded and meets the minimum octane rating requirement.

Before using an oxygenated fuel, confirm the fuel's contents. Some states / Provinces require this information to be posted on the fuel pump.

The following are Wacker Neuson approved percentages of oxygenates:

ETHANOL - (ethyl or grain alcohol) 10% by volume. You may use gasoline containing up to 10% ethanol by volume (commonly referred to as E10). Gasoline containing more than 10% ethanol (such as E15, E20, or E85) may not be used because it could damage the engine.

If you notice any undesirable operating symptoms, try another service station, or switch to another brand of gasoline.

Fuel system damage or performance problems resulting from the use of an oxygenated fuel containing more than the percentages of oxygenates mentioned above are not covered under warranty.

3.3 Determining Power Requirements

This generator is designed to operate single-phase, 60 Hz appliances running at 120 VAC or 240 VAC. Check the nameplate or label provided on tools and appliances to make sure their power requirements match the power output of the generator.

Some appliances and tools require a surge of current when starting. This means that the amount of power needed to initially start the equipment is larger than the power required to keep it running. The generator must be capable of supplying this “surge” current. Other types of appliances require more power than is actually stated on their nameplate.

The information in “Approximate Starting Power Requirements” is offered only as a general guideline to help you in determining power requirements for different types of equipment. Check with your nearest Wacker Neuson dealer, or contact the manufacturer or dealer of the tool or appliance, with questions regarding its power requirements.

NOTICE: If a tool or appliance does not reach full speed within a few seconds when switched on, turn it off immediately to avoid damage.

Approximate Starting Power Requirements

- Incandescent lights and appliances such as irons and hot plates, which use a resistive-type heating element, require the same wattage to start and run as is stated on their nameplates.
- Fluorescent and mercury lamps require 1.2–2 times their stated wattage to start.
- Electrical motors and many types of electrical tools often require a large starting current. The amount of starting current depends on the type of motor and its use.
- Most electrical tools require 1.2–3 times their stated wattage for starting.
- Loads such as submersible pumps and air compressors require a very large force to start. They need as much as 3–5 times the wattage stated on the nameplate in order to start.

If the wattage is not given for a particular tool or appliance, it can be calculated by multiplying its voltage and amperage requirements:

Single Phase: VOLTS x AMPS = WATTS

3.4 Installation

Place the generator in an area where it will not be exposed to rain, snow, or direct sunlight. Make sure it is positioned on firm, level ground, so it will not slide or shift. Position the engine exhaust away from areas where people may be present.

The surrounding area must be free from water and moisture. All components must be protected from excessive moisture.

3.5 Recommended Battery (GPS only)

This generator is shipped without a battery. The recommended battery to be used is:

Battery Type	50-N18L-A
Voltage	12 V
Capacity	20 A/h
L x W x H	206 x 90 x 164 mm (8-1/8 x 3-9/16 x 6-7/16 in.)

3.6 Battery Tray Installation (GPS only)

- 3.6.1 Align the holes found in the battery tray **(a)** to the holes on the frame cross-member
- 3.6.2 Insert M8 x 14 screws **(b)** through the tray then through the holes of the cross-member.
- 3.6.3 Insert the nuts **(c)** onto the screws and tighten. Torque nuts to 18.75 Nm. (13.5 ft.lbs).
- 3.6.4 Align the holes in the battery tube **(d)** to the holes in front of the battery tray.
- 3.6.5 Insert M8 x 35 screws **(e)** through the battery tray then through the tube.
- 3.6.6 Insert the nuts **(f)** onto the screws and tighten. Torque nuts to 18.75 Nm. (13.5 ft.lbs).
- 3.6.7 Insert the tube clamps **(g)** onto the upper frame tube and align the holes to the holes of the battery tube.
- 3.6.8 Insert M8 x 35 screws **(h)** through the battery tube then through the tube clamps.
- 3.6.9 Insert the nuts **(j)** onto the bolts and tighten. Torque nuts to 18.75 Nm. (13.5 ft.lbs).
- 3.6.10 Slide the J-bolt **(k)** through the holes found in the battery holder **(l)**.
- 3.6.11 Insert the rounded end of the J-bolt **(k)** into the slot of the battery tray and insert the tip of the J-bolt through the hole.

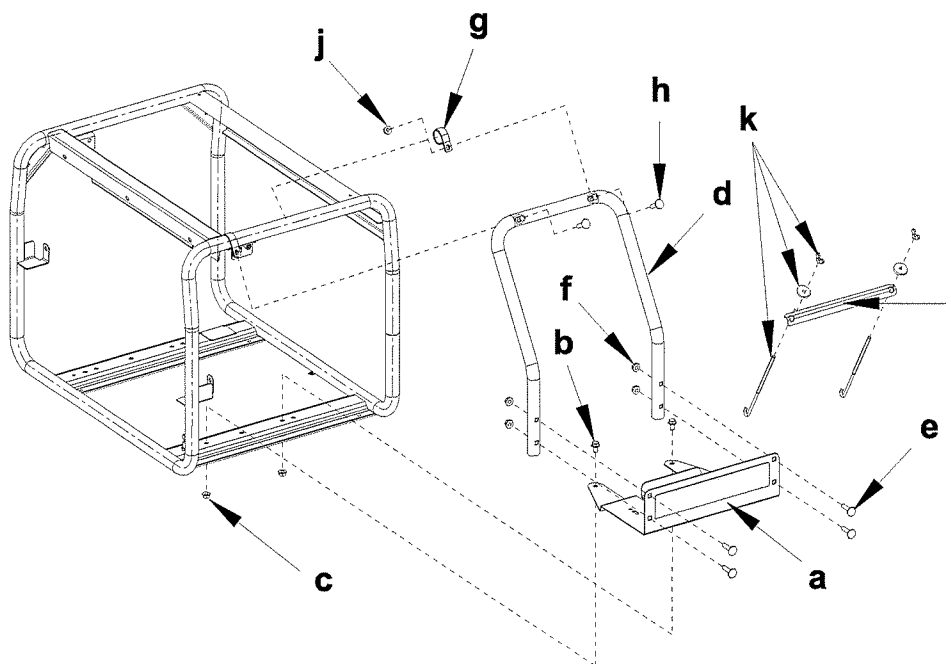

3.7 Wheel Kit

The wheel kit (Part No. 0161308) is a standard item on Item Number 0620012, 0620015, 0620043 and 0620046 only. It is available as an option on all other models.

- 3.7.1 Hoist the generator, and align the axle **(c)** with the lower cross-member of frame.
- 3.7.2 Insert the axle brackets **(k)** over the axle and align the holes found in the axle bracket to the holes of the cross-member. Ensure that the brackets extend under the tube of the frame.
- 3.7.3 Insert M6 x 16 screws **(l)** through the outer holes on the cross-member, then through the holes of the axle bracket.
- 3.7.4 Insert M6 nuts **(m)** onto the screws and tighten. Torque to 7.5 Nm (5.25 ft.lbs.).
- 3.7.5 Assemble the washers **(g)** next to the rings **(h)**, then add the wheels **(d)**.
- 3.7.6 Add the washers **(g)** next to the wheels, then insert the pins **(f)** into the holes of the axle and separate the legs of the pins.
- 3.7.7 Align the holes found in the leg bracket **(b)** to the holes of the lower cross-member.
- 3.7.8 Insert M6 x 16 screws **(l)** through the outer holes on the cross-member, then through the holes of the leg bracket.
- 3.7.9 Insert M6 nuts **(n)** onto the screws and tighten. Torque to 7.5 Nm (5.25 ft.lbs.).
- 3.7.10 Insert M8 x 30 screw **(o)** through the hole in the leg bracket and through the hole in cross-member.
- 3.7.11 Insert M8 nut **(p)** onto the screw and tighten. Torque to 18.75 Nm (13.5 ft.lbs.).
- 3.7.12 Align the holes in the rubber foot mounts **(e)** to the holes of the leg bracket.
- 3.7.13 Insert M6 x 20 screws **(m)** through the leg bracket, then through the holes of the rubber foot mounts.
- 3.7.14 Insert the nuts **(n)** onto the screws and tighten. Torque to 7.5 Nm (5.25 ft.lbs.).
- 3.7.15 Align the holes found in the handles **(a, j)** to the holes of the brackets **(1)** on the frame.
- 3.7.16 Insert M6 x 16 screws **(l)** through the handles, then through the brackets on the frame.
- 3.7.17 Insert nuts **(m)** onto the screws and tighten. Torque to 7.5 Nm (5.25 ft.lbs.).

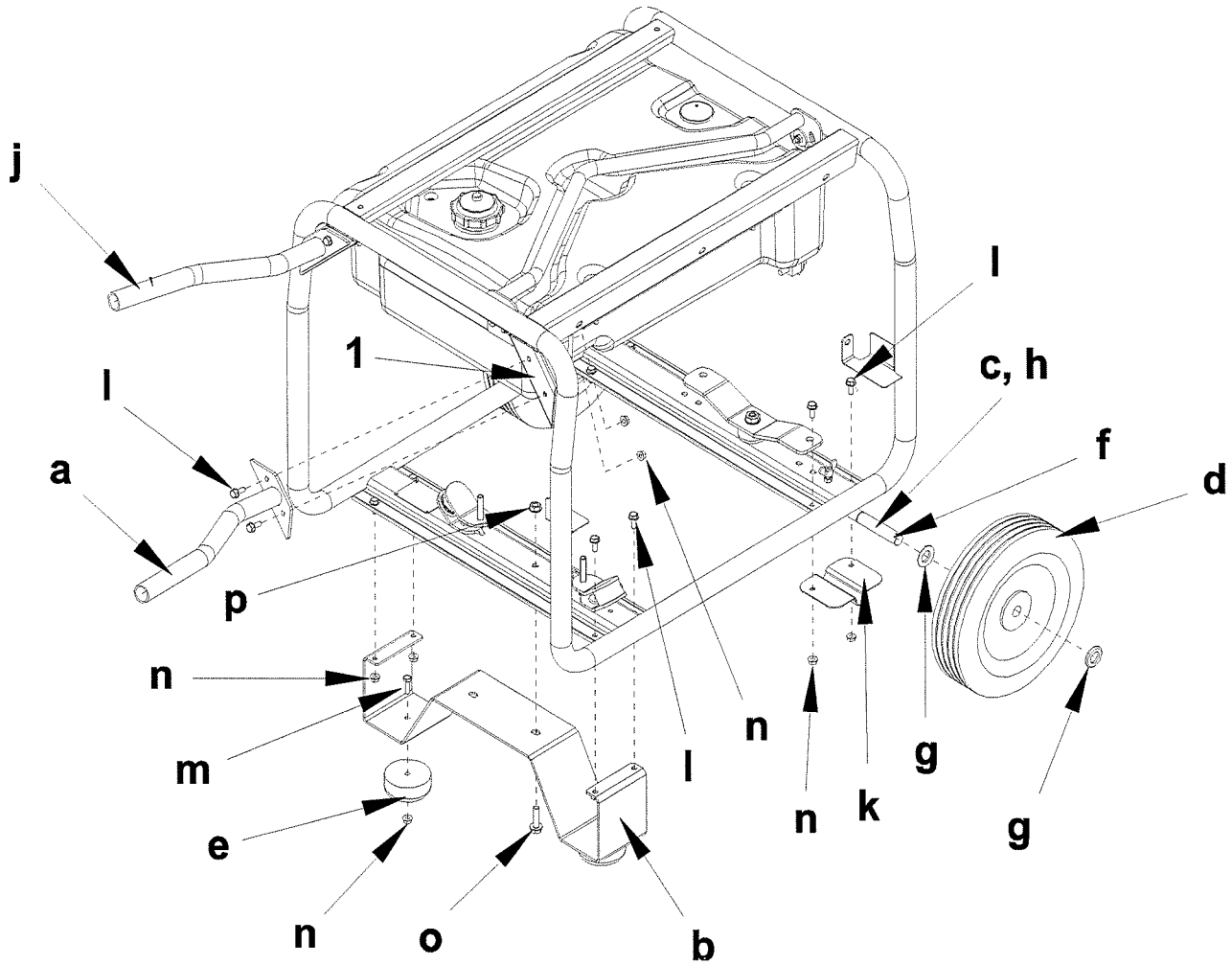

3.8 Generator Derating

All generators are subject to derating for altitude and temperature. Internal combustion engines, unless modified, run less efficiently at higher altitudes due to the reduction of air pressure. This translates into a lack of power and thus reduction in generator output. Temperature affects both engine and generator performance. As temperature increases, an engine will run less efficiently and more resistance will be found in electrical components. Therefore, as the temperature increases, the output of the generator decreases. Altitude also affects the cooling capacity of air—the higher the altitude the less dense the air is and thus the lower its ability to transfer heat.

For every increase in altitude of 500 m (1650 ft.) above 1000 m (3300 ft.), the output of the generator will be reduced by 3%. For every increase of 5° C (9° F) in ambient temperature above 40° C (104° F), the output of the generator will be reduced by 3%. Use the tables shown for altitude and temperature deration factors. It may be necessary to consider both altitude and ambient temperature deration factors to determine true generator output.

Ambient Temp. °C (°F)	Derate	Factor
45 (113)	3 %	0.97
50 (122)	6 %	0.94
55 (131)	9 %	0.91
60 (140)	12 %	0.88

Altitude m (ft.)	Derate	Factor
1500 (4900)	3 %	0.97
2000 (6600)	6 %	0.94
2500 (8200)	9 %	0.91
3000 (9900)	12 %	0.88
3500 (11500)	15 %	0.85
4000 (13100)	18 %	0.82

3.9 Grounding the Generator

Location

A ground connection (**a**) is located on the generator frame.

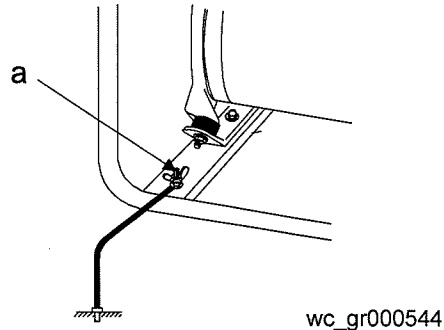

Function

This ground connection is used for electrically grounding the generator when necessary to comply with the National Electrical Code and other federal, state, and local regulations. For grounding requirements in your area, consult with a qualified electrician, electrical inspector, or local agency having jurisdiction over electrical compliance.

- If the generator is used at a construction site, there may be additional regulations which must be observed.
- In some areas, generators are required to be registered with local utility companies.
- There is a conductor between the generator (stator neutral winding) and the frame.

3.10 Operating Heavy Loads

Limit operations requiring the maximum rated output of 5600 W to 20–30 minutes. For continuous operation do not exceed the continuous rated output of 5000 W.

NOTICE: DO NOT exceed the current limit specified on the control panel for any receptacle.

3.11 Use of Extension Cords

When a long extension cord is used to connect an appliance or tool to the generator, a voltage loss occurs—the longer the cord, the greater the voltage loss. This results in less voltage being supplied to the appliance or tool and increases the amount of current draw or reduces performance. A heavier cord with a larger wire size will reduce the voltage loss.



Damaged extension cords can cause electrical shock, resulting in serious injury or death. DO NOT use worn, bare, or frayed cords. Replace damaged cords immediately.

Use the chart below as a guide for selecting proper cable size.

Current (Amps)	Load in Watts		Maximum Cable Length in Feet			
	120V	240V	#10	#12	#14	#16
2.5	300	600	1000.	600	375	250
5	600	1200	500	300	200	125
7.5	900	1800	350	200	125	100
10	1200	2400	250	150	100	-
15	1800	3600	150	100	65	-
20	2400	4800	125	75	50	-

Use only extension cords rated for outdoor use and equipped with a third-wire ground.

NOTICE: Operating equipment at low voltage can cause it to overheat.

3.12 Control Panel

Ref.	Description	Ref.	Description
a	Engine Switch	g	GFCI test button
b	Auto Idle Switch	h	GFCI reset button
c	Twist-lock receptacle - 120V	j	Twist-lock receptacle - 120/240V
d	Main Circuit Breaker	k	Ignition Switch (GPS only)
e	Voltage Selector Switch	m	20A circuit breaker (CAN only)
f	Duplex receptacle - 120V	n	30A circuit breaker (CAN only)

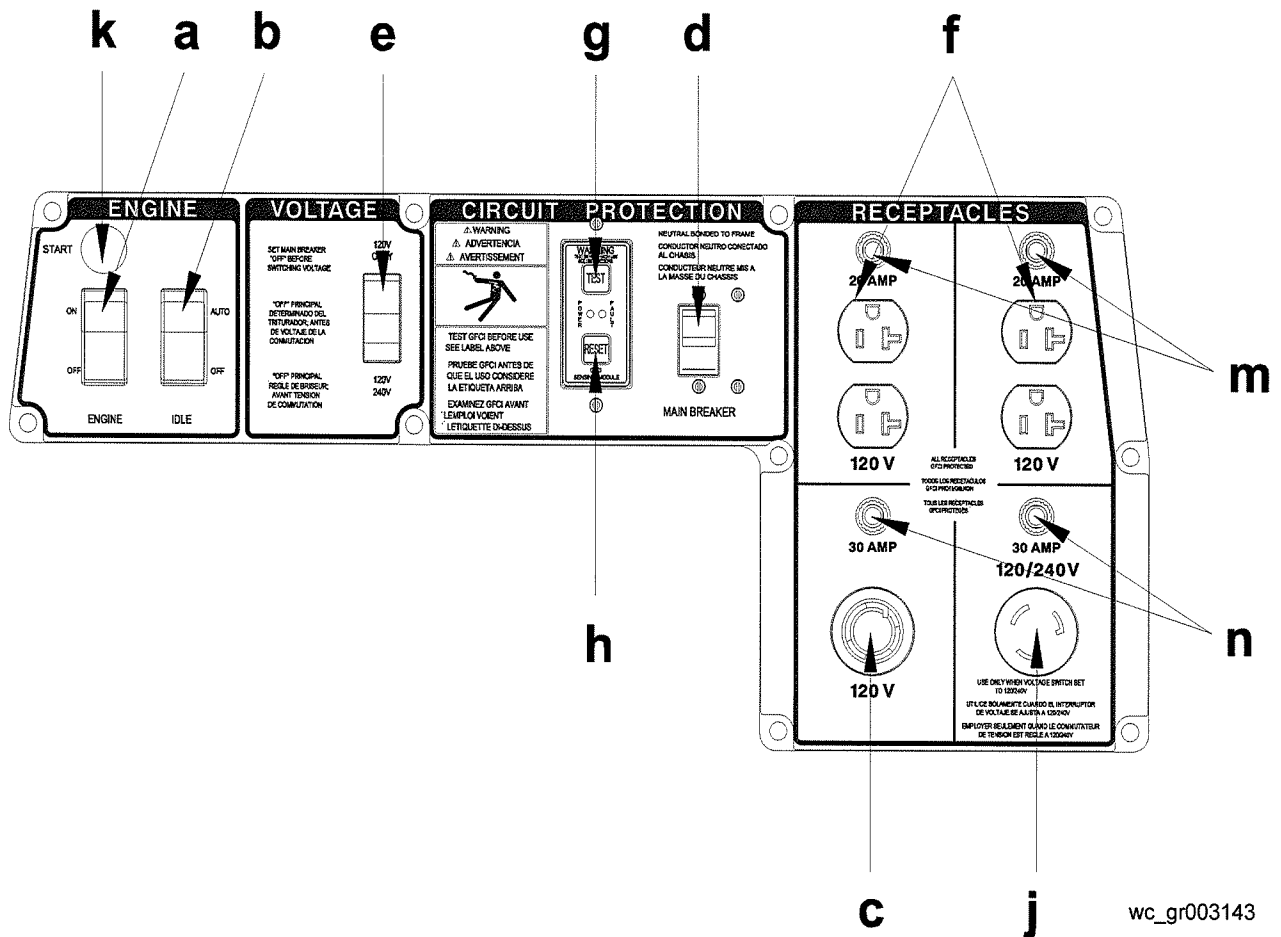

wc_gr003143

3.13 Ground Fault Interrupt (GFI / GFCI)

The GFCI should be tested for proper operations every time the generator is used.

Normal operating state - sensing device green LED is “ON” and circuit breaker is at “ON” position.

- 3.13.1 Press “TEST” button (g). Green LED should go “OUT” and red LED should come “ON” and circuit breaker should trigger to “OFF” position (d).
- 3.13.2 If sensing device LED or breaker does not trip or change state, “DO NOT USE”. Consult an electrician for assistance.
- 3.13.3 Press “RESET” button (h). Red LED should turn “OFF” and green LED should turn “ON”.
- 3.13.4 Manually reset (switch) circuit breaker to “ON” position to restore circuit power (d).

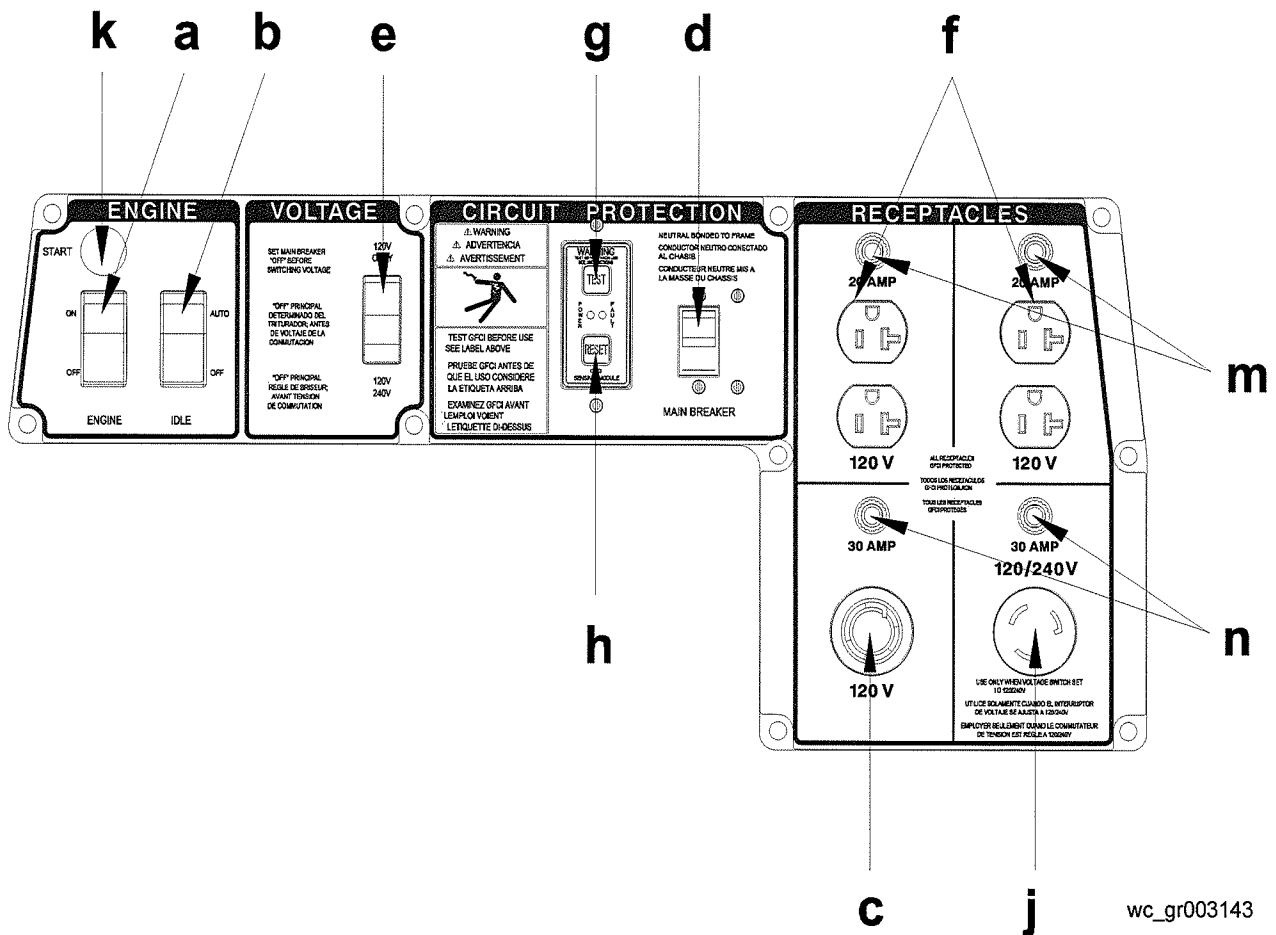

wc_gr003143

3.14 Twist-Lock Receptacles

Twist-lock receptacles **(c, j)** are used at the 120V Amp and 120/240V outlets. These receptacles are protected by the GFCI.

To attach a power cord to a twist-lock receptacle, insert plug into receptacle and turn it clockwise to lock it in place.

3.15 Engine Auto Idle

The auto idle switch **(b)** automatically reduces engine speed approximately 7 seconds after all appliances or tools attached to the generator have been turned off. The engine automatically returns to full speed when a tool or appliance is turned back on.

To turn the auto idle feature on, push the auto idle switch to "AUTO". The AUTO setting is recommended while the generator is running to minimize fuel consumption. To avoid extended engine warm-up periods, keep switch set to "OFF" when starting the engine and until the engine reaches operating temperature.

3.16 Engine Speed

Generators require a fixed engine speed to maintain the correct voltage. Engine speed is controlled by a governor which automatically adjusts to varying loads on the engine to maintain a constant speed. See *Technical Data*. There is no throttle control. Use the Auto Idle switch on the generator to control engine speed.

3.17 Voltage Selector Switch

The voltage selector switch (e) allows the generator to operate in either single (120V) or dual voltage (120/240V) mode.

In single-voltage mode, use only the 120V twist-lock (c) and duplex receptacles (f1, f2). The full rated power of the generator is shared between the three receptacles.

In dual voltage mode both the 120V and 120/240V receptacles are powered; lower watts are available on receptacles (f1, f2, c). The 120/240V twist-lock receptacle (j) should be used in dual mode only. To achieve full power in this receptacle it should be used alone.

NOTICE: NEVER switch the voltage selector switch with the main breaker on! This can cause arcing and can damage the generator. Turn all tools and appliances off and place main breaker (d) in the OFF position before changing voltage switch position.

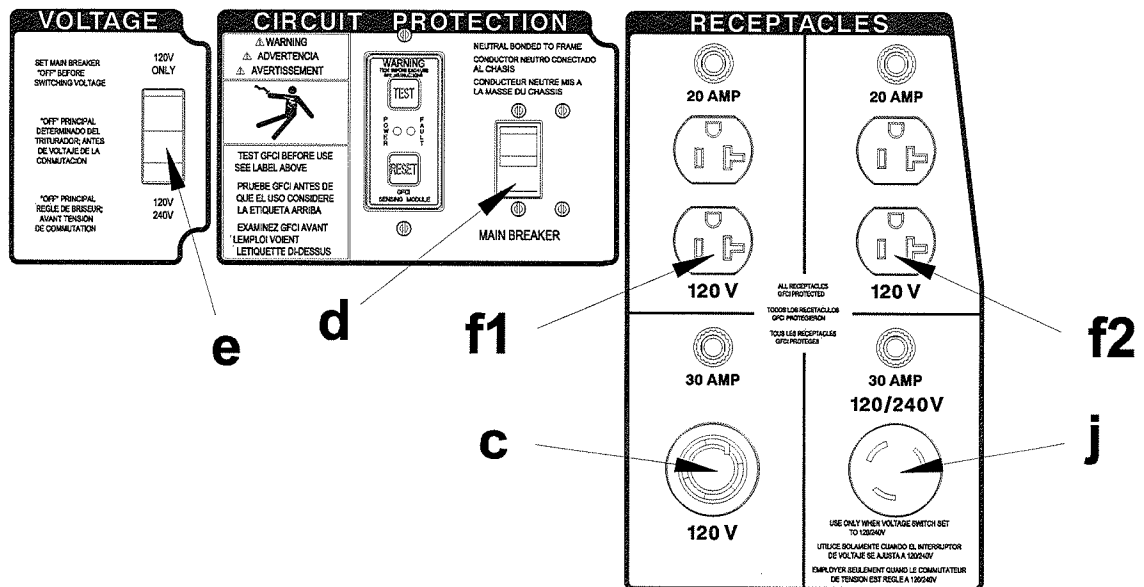

wc_gr003144

3.18 Before Starting

**DANGER**

- **Carbon monoxide.** Using a generator indoors CAN KILL YOU IN MINUTES. Generator exhaust contains carbon monoxide (CO). This is a poison you cannot see or smell. If you can smell the generator exhaust, you are breathing CO. But even if you cannot smell the exhaust, you could be breathing CO.

- 3.18.1 Read and understand the safety and operating labels and instructions at the beginning of this manual.
- 3.18.2 Inspect the generator for any signs of damage which may affect operation or pose a safety hazard.
- 3.18.3 Check:
- oil level in engine
 - fuel level
 - condition of air cleaner
 - tightness of external fasteners
 - condition of fuel lines.

Note: *The engine is equipped with an oil alert system. If the oil level in the engine drops too low, the engine will not start.*

- 3.18.4 Fill the fuel tank with fresh, regular, unleaded grade gasoline. Do not exceed the fuel tank capacity (see Technical Data).

NOTICE: Fill the tank after placing the machine on level ground.

- 3.18.5 DO NOT use an oil/gas mixture to fill the tank. The use of gasohol or any fuel containing more than 10% ethanol is not recommended. Consult the engine owner's manual for complete fuel specifications.

3.19 Starting

Before starting, be sure you read and understand all the safety and operating instructions in this manual.

- 3.19.1 Ensure that the generator is properly installed in an outdoor location. See Sections *Installation* and *Operator Safety while using Internal Combustion Engines* for installation warnings and safety guidelines.
- 3.19.2 Disconnect all loads from the generator and place the main circuit breaker switch in the OFF position (a2).
- 3.19.3 Set the auto idle switch to "OFF" (c).
- 3.19.4 Open the fuel valve (d1).

Note: If the engine is cold, move the choke lever to the closed position (e2). If the engine is warm, set the choke lever to the open position (e1).

- 3.19.5 On recoil start engines, turn the engine switch to "ON" (b1) and pull the starter rope (f).
- 3.19.6 On electric start engines, press the ignition switch (k) and hold until the engine starts. Release the switch after the engine starts.

NOTICE: DO NOT run the starter motor more than 5 seconds at a time or damage to the starter motor may occur. If the engine fails to start, release the switch and wait 10 seconds to let the starter motor cool before trying again.

Note: If the oil level in the engine is low, the engine will not start. If this happens, check the oil level and add oil as needed.

- 3.19.7 As the engine warms up, move the choke lever to the OPEN position (e1).
- 3.19.8 Allow the engine to warm up for a few minutes before placing the main breaker in the "ON" position (a1) and attaching loads.

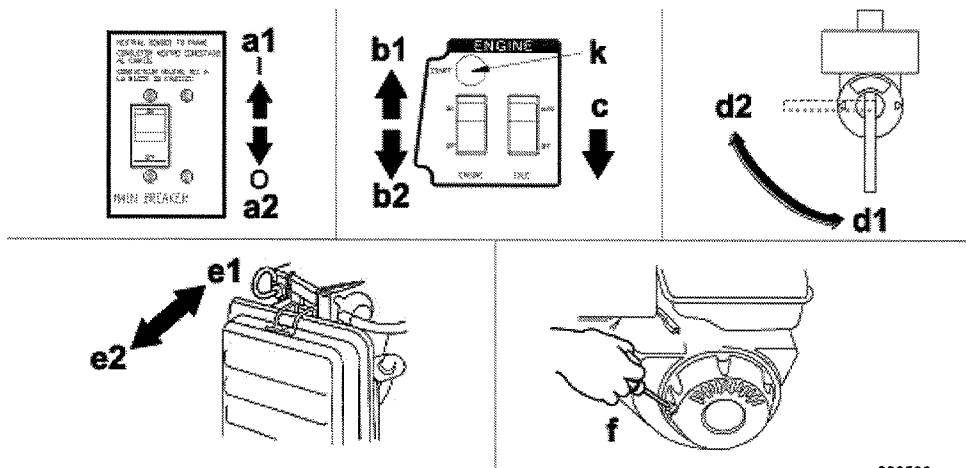

wc_gr002500

3.20 Stopping

- 3.20.1 Turn off and disconnect all tools and appliances attached to the generator.
- 3.20.2 Place the main circuit breaker in the OFF position **(a2)**.
- 3.20.3 Turn the engine switch to "OFF" **(b2)**.
- 3.20.4 Close the fuel valve **(d2)**.

Note: *To stop the engine quickly in an emergency, turn or press the engine switch to "OFF" **(b2)**.*

3.21 Emergency Shutdown Procedure

Procedure

If a breakdown or accident occurs while the machine is operating, follow the procedure below:

- 3.21.1 Stop the engine.
- 3.21.2 Turn off the fuel supply.
- 3.21.3 Disconnect tools from the machine.
- 3.21.4 Allow the machine to cool.
- 3.21.5 Contact the rental yard or machine owner for further instructions.

4 Maintenance

4.1 Maintaining the Emission Control System

Normal maintenance, replacement or repair of emission control devices and systems may be performed by any repair establishment or individual; however, warranty repairs must be performed by a dealer/service center authorized by WACKER NEUSON. The use of service parts that are not equivalent in performance and durability to authorized parts may impair the effectiveness of the emission control system and may have a bearing on the outcome of a warranty claim.

4.2 Periodic Maintenance Schedule

The table below lists basic machine and engine maintenance. Tasks designated with check marks may be performed by the operator. Tasks designated with square bullet points require special training and equipment.

Refer to the engine owner’s manual for additional information.

	Daily before starting	After first 20 hrs.	Every 50 hrs.	Every 100 hrs.	Every 300 hrs.
Check the fuel level.	✓				
Check the engine oil level.	✓				
Inspect the air filter. Replace as needed.	✓				
Check external hardware.	✓				
Clean the air cleaner element.*			■		
Inspect the shockmounts for damage.				✓	
Change the engine oil.*		■		■	
Clean the sediment cup or fuel strainer.				■	
Check and clean the spark plug.				■	
Check and adjust the valve clearance.					■
Clean the fuel tank.*					■
Check condition of the fuel lines. Replace when necessary.					■

*Service more frequently in dusty conditions.

4.3 Engine Oil

4.3.1 Drain the oil while the engine is still warm.

4.3.2 Remove the oil filler plug (a) and the drain plug (b) to drain the oil.

Note: *In the interests of environmental protection, place a plastic sheet and a container under the machine to collect any liquid that drains off. Dispose of this liquid in accordance with environmental protection legislation.*

4.3.3 Install the drain plug.

4.3.4 Fill the engine crankcase with the recommended oil up to the level of the plug opening (c). See section *Technical Data* for oil quantity and type.

4.3.5 Install the oil filler plug.

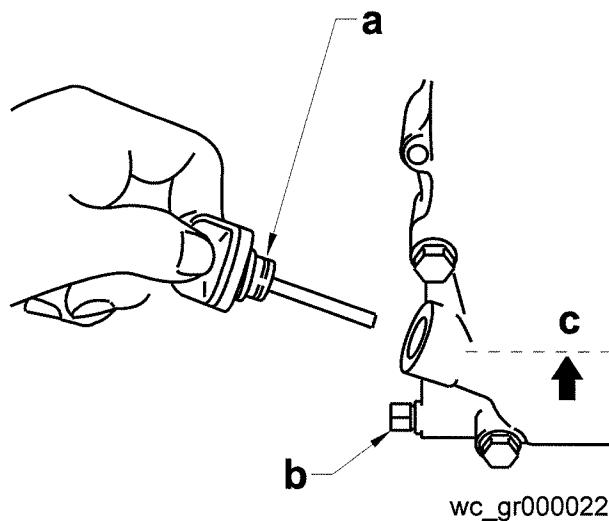

WARNING

Most used oil contains small amounts of materials that can cause cancer and other health problems if inhaled, ingested, or left in contact with skin for prolonged periods of time.

- ▶ Take steps to avoid inhaling or ingesting used engine oil.
- ▶ Wash skin thoroughly after exposure to used engine oil.

4.4 Servicing the Air Cleaner

Service the air cleaner frequently to prevent carburetor malfunction.

NOTICE: NEVER run the engine without the air cleaner. Severe engine damage will occur.



WARNING

NEVER use gasoline or other types of low flash-point solvents for cleaning the air cleaner. A fire or explosion could result.

To service:

- 4.4.1 Remove the air cleaner cover **(a)**. Inspect the element **(b)** for holes or tears. Replace the element if it is damaged.
- 4.4.2 Wash the foam element **(b)** in a solution of mild detergent and warm water. Rinse it thoroughly in clean water. Allow the element to dry thoroughly. Soak the element in clean engine oil and squeeze out excess oil.

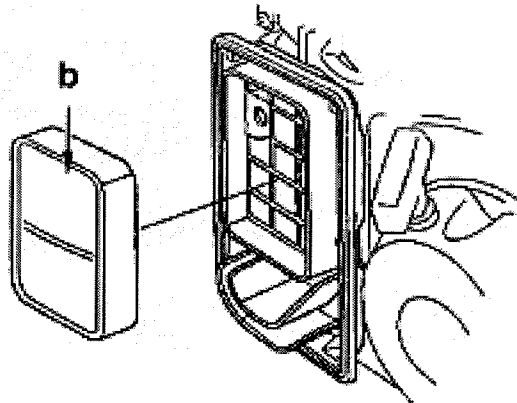
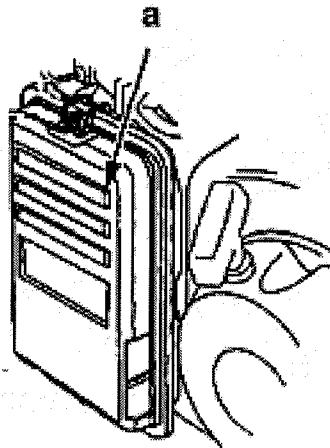
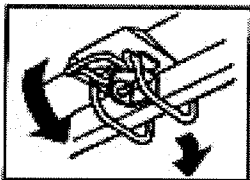
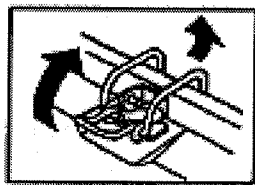

wc_gr002815

4.5 Spark Plug

Clean or replace the spark plug as needed to ensure proper operation. Refer to your engine operator's manual.



WARNING

The muffler becomes very hot during operation and remains hot for a while after stopping the engine. Do not touch the muffler while it is hot.

Note: Refer to section "Technical Data" for the recommended spark plug type and the electrode gap setting.

- 4.5.1 Remove the spark plug and inspect it.
- 4.5.2 Replace the spark plug if the insulator is cracked or chipped.
- 4.5.3 Clean the spark plug electrodes with a wire brush.
- 4.5.4 Set the electrode gap (a).
- 4.5.5 Tighten the spark plug securely.

NOTICE: A loose spark plug can become very hot and may cause engine damage.

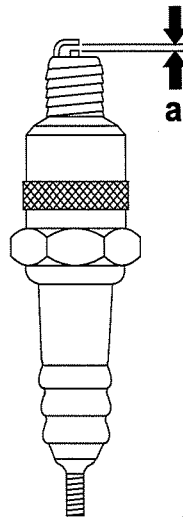

wc_gr000028

4.6 Cleaning the Sediment Cup

- 4.6.1 Turn the fuel valve off.
- 4.6.2 Remove the sediment cup (a) and the O-ring (b).
- 4.6.3 Wash both thoroughly in a nonflammable solvent. Dry and reinstall them.
- 4.6.4 Turn the fuel valve on and check for leaks.

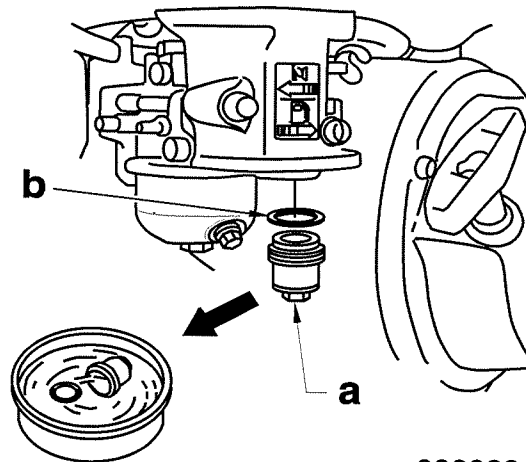

wc_gr000029

4.7 Engine Speed

Generators require a fixed engine speed to maintain the correct voltage. Engine speed is controlled by a governor which automatically adjusts to varying loads on the engine to maintain a constant speed. There is no throttle control.

To set the engine to the proper speed:

Turn the speed adjusting screw (b) in or out to obtain a no-load speed. See *Technical Data*.

NOTICE: Setting the engine speed too high or too low may damage tools and other appliances attached to the generator.

4.8 Long-Term Storage

Before storing the generator for a long period of time:

- 4.8.1 Close the fuel valve and remove and empty the sediment cup or fuel strainer.
- 4.8.2 Disconnect the fuel line from the carburetor. Place the open end of the fuel line into a suitable container and open the fuel valve to drain the fuel from the tank.



Gasoline is extremely flammable. Drain the fuel tank in a well-ventilated area. **DO NOT** drain the fuel tank in an area with flames or sparks.

- 4.8.3 Loosen the drain screw on the carburetor and drain any remaining fuel from the carburetor.
- 4.8.4 Change the engine oil.
- 4.8.5 Remove the spark plug and pour approximately 30 ml (1 ounce) of clean engine oil into the cylinder. Crank the engine a few turns to distribute the oil to the inside of the cylinder walls.
- 4.8.6 Pull the starter rope slowly until resistance is felt and leave the handle in this position. This ensures that the intake and exhaust valves are closed.
- 4.8.7 Store the generator in a clean, dry area.

4.9 Transporting the Machine



Let the engine cool before transporting the generator or storing it indoors, to avoid burns or fire hazards.

When transporting the generator:

- 4.9.1 Turn the engine fuel valve to the OFF position.
- 4.9.2 Position the generator level to prevent fuel from spilling.
- 4.9.3 Secure the generator by tying it down with a suitable rope.



When transporting the machine by hand, be sure to employ manpower commensurate with the weight of the machine. To avoid back injury when lifting the machine, bend the knees to pick it up rather than bending your back only.

4.10 Troubleshooting

Problem / Symptom	Reason / Remedy
If engine doesn't start, check that:	<ul style="list-style-type: none"> • Engine switch is on "Start". • Fuel valves under fuel tank and on engine are open. • Fuel tank has fuel. • Choke lever is in correct position. Choke should be closed when starting a cold engine. • All loads are disconnected from generator. • Spark plug is in good condition. • Spark plug cap is tight. • Engine oil level is adequate.
If engine starts but there is no power at receptacles, check that:	<ul style="list-style-type: none"> • Circuit breaker is closed. • Connector from generator to control panel is tight.
If engine starts but runs erratically, check that:	<ul style="list-style-type: none"> • Hose routing from the fuel tank to the engine is correct. For proper operation, the hose must run through the bushing in the lifting bracket. Refer to the Parts Book for illustration.
If the GFCI trips when a load is connected, check that:	<ul style="list-style-type: none"> • The connected equipment may be wired incorrectly or faulty. Contact equipment supplier. • See section <i>Determining Power Requirements</i>.

5 Technical Data

5.1 Generator

Item No.		GP 5600A	GP 5600A with wheel kit	GPS 5600A
Generator				
Maximum Output	W	5600		
Continuous Output	W	5000		
Type		Dual voltage, single phase, Auto voltage regulator system		
AC Voltages Available	volts phase	120 / 240 1ø		
Frequency	Hz	60		
Power Factor		1.0		
AC receptacles:				
125V duplex	amp	20		
125V duplex	amp	20		
125V twist-lock	amp	30		
125V/250V twist-lock	amp	30		
Main Circuit Breaker	amp	2-pole, 23 amp each pole		
L x W x H	mm (in.)	685 x 530 x 537 (27 x 21 x 21.2)	1003 x 686 x 677 (39.5 x 27 x 26.7)	870 x 530 x 537 (34.3 x 21 x 21.2)
Weight (dry)	Kg (lbs.)	89 (194)	98 (216)	97.1 (214)

5.2 Engine

Engine Power Rating

Net power rating per SAE J1349. Actual power output may vary due to conditions of specific use.

Item No.		GP 5600A	GPS 5600A
Engine			
Engine type		Single cylinder, 4-cycle, air-cooled, gasoline engine	
Engine make		Honda	
Engine model		GX 340 RT2	
Max. rated power @ rated speed	kW (Hp)	8 (10.7) @ 3600 rpm	
Spark plug		BPR6ES / W20EPR-U	
Electrode gap	mm (in.)	0.7 - 0.8 (0.028 - 0.031)	
Operating speed	rpm	3600	
Air cleaner	type	Dry type with oil-wetted foam pre-cleaner	
Battery	type V/ capacity Size (in.)	N/A	Y50-N18L-A 12V - 20 Amp-hour 8- ¹ / ₈ x 3- ⁹ / ₁₆ x 6- ⁷ / ₁₆
Engine lubrication	oil grade	SAE 10W30 service class SJ or higher	
Engine oil capacity	l (qts.)	1.1 (1.2)	
Fuel	type	Regular unleaded gasoline	
Fuel tank capacity	l (gal.)	18.7 (4.94)	
Fuel consumption	l (qts.)/ hr.	3.2 (3.4)	
Running time	hrs.	5.8	

Notes:



Emission Control Systems Information and Warranty

6 Emission Control Systems Information and Warranty

The Emission Control Warranty and associated information is valid only for the U.S.A., its territories, and Canada.

6.1 Emission Control System Background Information

Introduction

Wacker Neuson spark-ignited engines/equipment must conform with applicable Environmental Protection Agency (EPA) and the State of California emissions regulations. There are two types of emissions that fall under these regulations: 1) exhaust, and 2) evaporative. These regulations require that manufacturers warrant the emission control systems for defects in materials and workmanship.

Furthermore, EPA and California regulations require all manufacturers to furnish written instructions describing how to operate and maintain the engines/equipment including the emission control systems. This information is provided with all Wacker Neuson engines/equipment at the time of purchase.

Exhaust Emissions

The combustion process produces carbon monoxide, oxides of nitrogen, and hydrocarbons. Control of hydrocarbons and oxides of nitrogen is very important because, under certain conditions, they react to form photochemical smog when subjected to sunlight. Carbon monoxide does not react in the same way, but it is toxic.

Wacker Neuson utilizes lean carburetor settings and other systems to reduce the emissions of carbon monoxide, oxides of nitrogen, and hydrocarbons.

Evaporative Emissions

Evaporative emissions are fuel emissions and generally include emissions that result from permeation of fuel through the fuel-system materials or from ventilation of the fuel system.

Wacker Neuson utilizes low-permeation fuel lines and fuel tanks where applicable to reduce evaporative emissions.

Problems that may affect Emissions

If any of the following symptoms arise, have the engine/equipment inspected and repaired by a Wacker Neuson dealer/service center.

- Hard starting or stalling after starting
 - Rough idling
 - Misfiring or backfiring under load
 - Afterburning (backfiring)
 - Presence of black exhaust smoke during operation
 - High fuel consumption
-

Emission Control Systems Information and Warranty

Tampering and Altering

Tampering with or altering the emission control system may increase emissions beyond the legal limit. If evidence of tampering is found, Wacker Neuson may deny a warranty claim. Among those acts that constitute tampering are:

- Removing or altering of any part of the air intake, fuel, or exhaust systems.
- Altering or defeating the speed-adjusting mechanism causing the engine to operate outside its design parameters.

6.2 Limited Defect Warranty for Exhaust Emission Control System

See the supplied engine owner's manual for the applicable emission warranty statement.



Emission Control Systems Information and Warranty

6.3 Limited Defect Warranty for Wacker Neuson Evaporative Emission Control Systems

The Emission Control Warranty is valid only for the U.S.A., its territories, and Canada.

Wacker Neuson Sales Americas, LLC, N92 W15000 Anthony Avenue, Menomonee Falls, WI 53051, (hereinafter "Wacker Neuson") warrants to the initial retail purchaser and each subsequent owner, that this engine/equipment, including all parts of its evaporative emission control system, have been designed, built, and equipped to conform at the time of initial sale to all applicable evaporative emission regulations of the U.S. Environmental Protection Agency (EPA), and that the engine/equipment is free of defects in materials and workmanship which would cause this engine/equipment to fail to conform to EPA regulations during its warranty period.

Wacker Neuson is also liable for damages to other engine/equipment components caused by a failure of any warranted parts during the warranty period.

Limited Defect Warranty Period for Wacker Neuson Evaporative Emission Control Systems

The warranty period for this engine/equipment begins on the date of sale to the initial purchaser and continues for a minimum of two (2) years. For the warranty terms for your specific engine/equipment, visit wackerneuson.com.

Any implied warranties are limited to the duration of this written warranty.

What is covered

Wacker Neuson recommends the use of genuine Wacker Neuson parts, or the equivalent, whenever maintenance is performed. The use of replacement parts not equivalent to the original parts may impair the effectiveness of the engine/equipment emission controls systems. If such a replacement part is used in the repair or maintenance of the engine/equipment, assure yourself that such part is warranted by its manufacturer to be equivalent to the parts offered by Wacker Neuson in performance and durability. Furthermore, if such a replacement part is used in the repair or maintenance of the engine/equipment, and an authorized Wacker Neuson dealer/service center determines it is defective or causes a failure of a warranted part, the claim for repair of the engine/equipment may be denied. If the part in question is not related to the reason the engine/equipment requires repair, the claim will not be denied.

For the components listed in the following table, an authorized Wacker Neuson dealer/service center will, at no cost to you, make the necessary diagnosis, repair, or replacement necessary to ensure that the engine/equipment complies with the applicable EPA regulations. All defective parts replaced under this warranty become property of Wacker Neuson.



Emission Control Systems Information and Warranty

System Covered	Components
Evaporative emissions	Fuel tank (if applicable)
	Fuel tank cap (if applicable)
	Fuel line (if applicable)
	Fuel line fittings (if applicable)
	Clamps (if applicable)
	Carbon canister (if applicable)
	Purge port connector (if applicable)
Miscellaneous parts associated with the evaporative emission control system	Clamps
	Gaskets
	Mounting brackets

What is not covered

- Failures other than those resulting from defects in material or workmanship.
- Any systems or parts which are affected or damaged by owner abuse, tampering, neglect, improper maintenance, misuse, improper fueling, improper storage, accident and/or collision; the incorporation of, or any use of, add-on or modified parts, or unsuitable attachments, or the alteration of any part.
- Replacement of expendable maintenance items made in connection with required maintenance services after the item's first scheduled replacement as listed in the maintenance section of the engine/equipment operator's manual, such as spark plugs and filters.
- Incidental or consequential damages such as loss of time or the use of the engine/equipment, or any commercial loss due to the failure of the engine/equipment.
- Diagnosis and inspection charges that do not result in warranty-eligible service being performed.
- Any non-authorized replacement part, or malfunction of authorized parts due to use of non-authorized parts.

Owner's Warranty Responsibility

The engine/equipment owner, is responsible for the performance of the required maintenance listed in the Wacker Neuson engine/equipment operator's manual. Wacker Neuson recommends that all receipts covering maintenance on the engine/equipment be retained, but Wacker Neuson cannot deny warranty coverage solely for the lack of receipts or for the failure to ensure the performance of all scheduled maintenance.

Normal maintenance, replacement, or repair of emission control devices and systems may be performed by any repair establishment or individual; however, warranty repairs must be performed by an authorized Wacker Neuson dealer/service center.

The engine/equipment must be presented to an authorized Wacker Neuson dealer/service center as soon as a problem exists. Contact Wacker Neuson Product



Emission Control Systems Information and Warranty

Support Department (1-800-770-0957) or visit wackerneuson.com to find a dealer/service center in your area, or to answer questions regarding warranty rights and responsibilities.

How to Make a Claim

In the event that any emission-related part is found to be defective during the warranty period, you shall notify Wacker Neuson Product Support Department (1-800-770-0957), and you will be advised of the appropriate dealer/service center where warranty repair can be performed. All repairs qualifying under this limited warranty must be performed by an authorized Wacker Neuson dealer/service center.

You must take your Wacker Neuson engine/equipment along with proof of original purchase date, at your expense, to the authorized Wacker Neuson dealer/service center during their normal business hours.

For owners located more than 100 miles from an authorized dealer/service center (excluding the states with high-altitude areas as identified in 40 CFR Part 1068, Appendix III), Wacker Neuson will pay for pre-approved shipping costs to and from an authorized Wacker Neuson dealer/service center.

Claims for repair or adjustment found to be caused solely by defects in material or workmanship will not be denied because the engine/equipment was not properly maintained and used.

The warranty repairs should be completed in a reasonable amount of time, not to exceed 30 days.



6.4 California Evaporative Emission Control Warranty Statement

Your Warranty Rights and Obligations

The California Air Resources Board and Wacker Neuson Corporation, Inc., are pleased to explain the evaporative emission control system (EECS) warranty on your model year 2008 and later portable generator. In California, new portable generators must be designed, built and equipped to meet the State's stringent anti-smog standards. Wacker Neuson Corporation must warrant the EECS on your portable generator for the period of time listed below, provided there has been no abuse, neglect or improper maintenance of your portable generator.

Your EECS on your model year 2008 and later portable generator includes the fuel and vent line, fuel and vent line clamps, fuel and vent line fittings, carbon canister, fuel tank and fuel tank cap, purge port connector, gaskets, and mounting brackets.

Where a warrantable condition exists, Wacker Neuson Corporation will repair your portable generator at no cost to you including diagnosis, parts and labor.

Manufacturer's Warranty Coverage

This EECS is warranted for two years from the initial date of purchase. If any evaporative emission-related part on your equipment is defective, the part will be repaired or replaced by Wacker Neuson Corporation at no charge to you. The owner shall not be charged for diagnostic labor that leads to determination that a warranted part is in fact defective, provided that such diagnostic work is performed at a Wacker Neuson Corporation authorized service center.

Warranty Period

Any warranted part that is not scheduled for replacement as required maintenance, or which is scheduled only for regular inspection to the effect of "repair or replace as necessary", shall be warranted for two years. Any warranted part that is scheduled for replacement as required maintenance shall be warranted for a time not less than the remaining warranty period.

Owner's Warranty Responsibilities

As the portable generator owner, you are responsible for performance of the required maintenance listed in your Operator's Manual. Wacker Neuson Corporation recommends that you retain all receipts covering maintenance on your portable generator, but Wacker Neuson Corporation cannot deny warranty solely for the lack of receipts.

As the portable generator owner, you should however be aware that Wacker Neuson Corporation may deny you warranty coverage if your portable generator or a part has failed due to abuse, neglect, or improper maintenance or unapproved modifications.

You are responsible for presenting your portable generator to Wacker Neuson Corporation's authorized service center as soon as the problem exists. The warranty repairs should be completed in a reasonable amount of time, not to exceed 30 days. If you have a question regarding your warranty coverage, you should contact your nearest authorized Wacker Neuson service center or call 1-800-770-0957.

Emission Control Systems Information and Warranty

What is not Covered

All failures caused by abuse, neglect, or improper maintenance are not covered. In addition, the use of add-on or modified parts will be grounds for disallowing a warranty claim.

What is covered

The repair or replacement of any warranted part otherwise eligible for warranty coverage may be excluded from such warranty coverage if Wacker Neuson Corporation demonstrates that the portable generator has been abused, neglected, or improperly maintained, and that such abuse, neglect, or improper maintenance was the direct cause of the need for repair or replacement of the part. That notwithstanding, any adjustment of a component that has a factory installed, and properly operating, adjustment limiting device is still eligible for warranty coverage. The following emission warranty parts are covered:

Systems Covered	Components
Evaporative control system	Fuel and vent line
	Fuel and vent line clamps
	Fuel and vent line fittings
	Carbon canister
	Fuel tank
	Fuel tank cap
	Purge port connector
Miscellaneous parts associated with the evaporative emission control system	Gaskets
	Mounting brackets

6.5 Limited Defect Warranty for Exhaust Emission Control System

See the supplied engine owner's manual for the applicable emission warranty statement.

7 Schematics

7.1 Wire Colors

Wire Colors							
B	Black	R	Red	Y	Yellow	Or	Orange
G	Green	T	Tan	Br	Brown	Pr	Purple
L	Blue	V	Violet	Cl	Clear	Sh	Shield
P	Pink	W	White	Gr	Gray	LL	Light blue

7.2 US Machines—Electrical Schematic

Ref.	Description	Ref.	Description
A	Generator	E	Honda Engine
B	Control box		
C	Electric start engines (GPS)		

Ref.	Description	Ref.	Description
1	Main stator winding 1	12	Engine ON / OFF switch
2	Main stator winding 2	13	Rectifier
3	Auto idle unit	14	Rotor winding/brushes
4	Main circuit breaker	15	Secondary (excitation) winding
5	Voltage selector switch (120/240V position shown)	16	DC winding
6	Duplex receptacle—120V	17	Automatic voltage regulator (AVR)
7	Twist-lock receptacle—120V	18	15A fuse (GPS only)
8	Twist-lock receptacle—120/240V	19	Ignition switch (GPS only)
9	Auto idle switch	20	GFCI
10	5A fuse	21	Neutral bond wire
11	Capacitor		

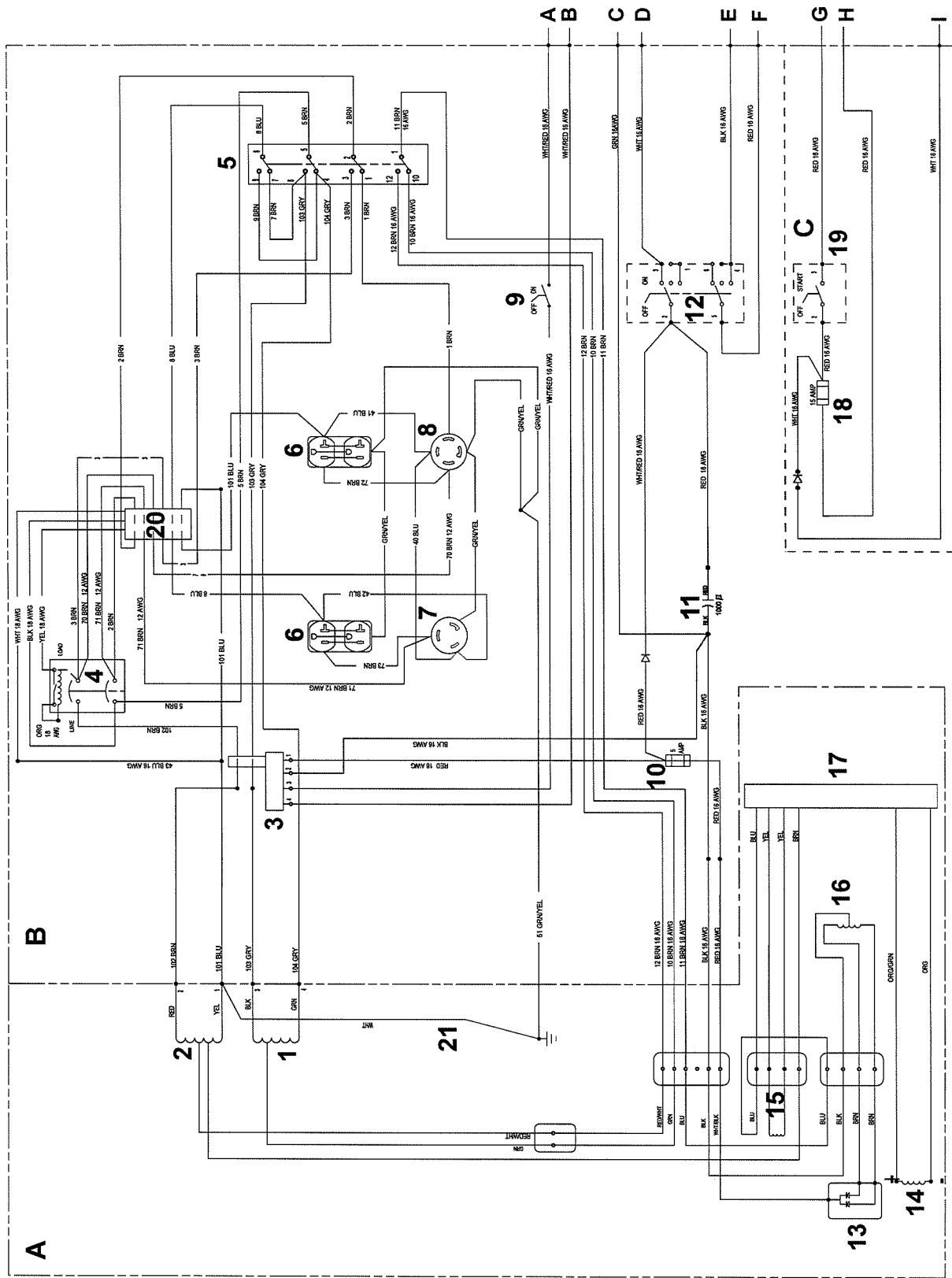

wc_gr008235

7.3 CSA Machines—Electrical Schematic

Ref.	Description	Ref.	Description
A	Generator	E	Honda Engine
B	Control box		
C	Electric start engines (GPS)		

Ref.	Description	Ref.	Description
1	Main stator winding 1	12	Engine ON / OFF switch
2	Main stator winding 2	13	Rectifier
3	Auto idle unit	14	Rotor winding/brushes
4	Main circuit breaker	15	Secondary (excitation) winding
5	Voltage selector switch (120/240V position shown)	16	DC winding
6	Duplex receptacle—120V	17	Automatic voltage regulator (AVR)
7	Twist-lock receptacle—120V	18	15A fuse (GPS only)
8	Twist-lock receptacle—120/240V	19	Ignition switch (GPS only)
9	Auto idle switch	20	GFCI
10	5A fuse	21	Neutral bond wire
11	Capacitor		

7.4 Engine Wiring

Ref.	Description	Ref.	Description
A	Generator	D	Honda Engine
B	Control box		
C	Electric start engines (GPS)		

Ref.	Description	Ref.	Description
1	Idle solenoid	6	Solenoid (GPS only)
2	Fuel cut solenoid	7	Starter (GPS only)
3	Oil level sender	8	Charging coil (GPS only)
4	Spark plug	9	Battery (GPS only)
5	Coil		

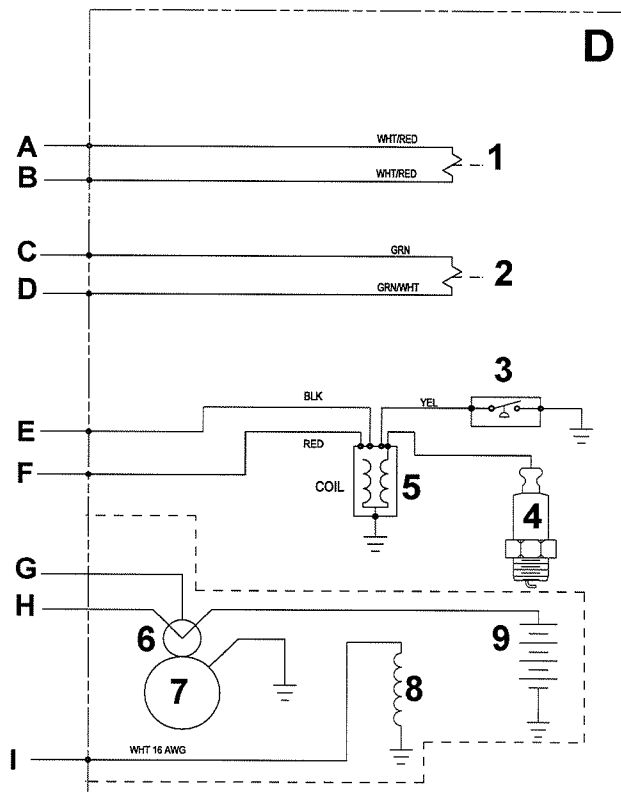

wc_gr008237



**WACKER
NEUSON**

www.wackerneuson.com

Wacker Neuson SE, Preußenstraße 41, D-80809 München, Tel.: +49-(0)89-3 54 02-0 Fax: +49 - (0)89-3 54 02-390
Wacker Neuson Production Americas LLC, N92W15000 Anthony Ave., Menomonee Falls, WI 53051

Tel. : (262) 255-0500 Fax: (262) 255-0550 Tel.: (800) 770-0957

Wacker Neuson Limited - Room 1701-03 & 1717-20, 17/F. Tower 1, Grand Century Place, 193 Prince Edward Road West, Mongkok, Kowloon, Hongkong.
Tel: (852) 3605 5360, Fax: (852) 2758 0032